

N-type Connectors 50 Ohm



7913

Type Male Solder Clamp Style Connector to suit RG213 or RG214 cable

Tri-Metal Plated Low PIM



A = 8.5 mm
C = 4.0 mm

7917

N-Type Male Solder Connector to suit RG58 cable

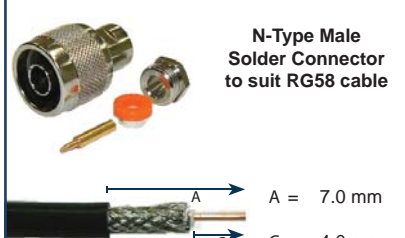

A = 7.0 mm
C = 4.0 mm

7923-3

N-Type Male Crimp Connector to suit RG59 cable

Tri-Metal Plated Low PIM

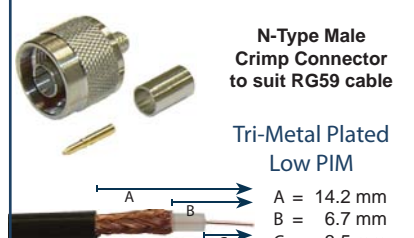

A = 14.2 mm
B = 6.7 mm
C = 3.5 mm

7925

N-Type Cable Termination Screw Mount



7930

N-Type Male Solder Connector to suit RU400 or RG8 cable

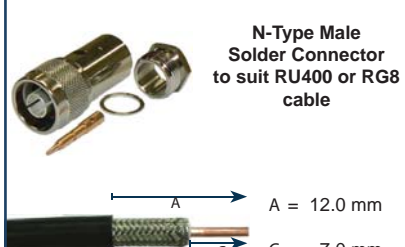

A = 12.0 mm
C = 7.0 mm

7930-4

N-Type Male Solderless Clamp Style Connector to suit RU400 or RG8 cable

Tri-Metal Plated Low PIM



A = 9.0 mm
Fitting Instructions are supplied

7932-4

Right-Angle N-Type Male Crimp Connector to suit RG214 cable

Tri-Metal Plated Low PIM



A = 20.0 mm
C = 5.0 mm

7933-2

N-Type Male Crimp Connector to suit RG58 cable

Tri-Metal Plated Low PIM

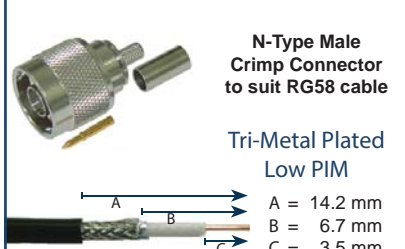

A = 14.2 mm
B = 6.7 mm
C = 3.5 mm

7937

N-Type Male Crimp Connector to suit RG213 cable

Tri-Metal Plated Low PIM

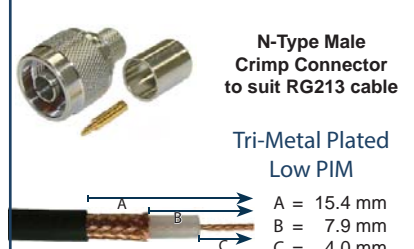

A = 15.4 mm
B = 7.9 mm
C = 4.0 mm

7937-2

N-Type Male Crimp Connector to suit RG214 cable

Tri-Metal Plated Low PIM

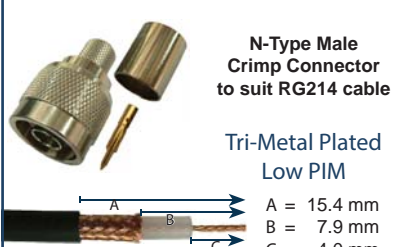

A = 15.4 mm
B = 7.9 mm
C = 4.0 mm

8219

Right-Angle N-Type Male Solder Connector to suit RG58 cable



A = 15.0 mm
B = 5.0 mm
C = 3.0 mm

8226

N-Type Male Crimp Connector to suit RU400 or RG8 cable

Tri-Metal Plated Low PIM

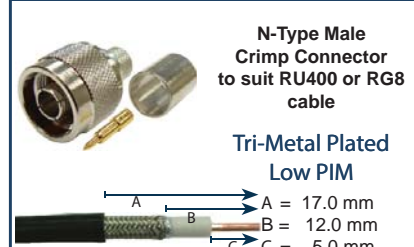

A = 17.0 mm
B = 12.0 mm
C = 5.0 mm

8278

N-Type Male Crimp Connector to suit RG174 or RG316 cable

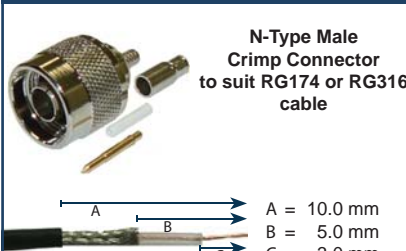

A = 10.0 mm
B = 5.0 mm
C = 3.0 mm

8283

N-Type Male Crimp Connector to suit RG223 cable

Tri-Metal Plated Low PIM



A = 10.0 mm
C = 5.0 mm

8286

Right-Angle N-Type Male Connector to suit RU400 or RG8 cable, crimp with solder pin

Tri-Metal Plated Low PIM

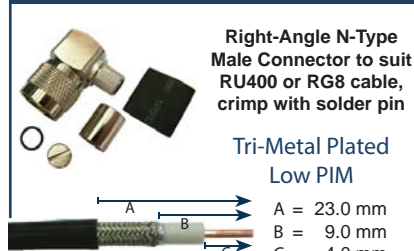

A = 23.0 mm
B = 9.0 mm
C = 4.0 mm

N-type Connectors 50 Ohm



7914

N-Type Female Flange Mount Receptacle



C = 4.0 mm

7915

N-Type Female SHM Receptacle



C = 4.0 mm

7916

N-Type Female Solder Connector to suit RG213 cable



A = 10.0 mm
C = 5.0 mm

7918

N-Type Female Solder Connector to suit RG58 cable



A = 7.0 mm
B = 2.0 mm
C = 5.0 mm

7923

N-Type Female Crimp Connector with Solder Pin to suit RG59 cable



A = 14.5 mm
B = 7.0 mm
C = 5.0 mm

7923-2

N-Type Female Solder Connector to suit RG59 cable



A = 7.0 mm
B = 2.0 mm
C = 5.0 mm

7932

N-Type Female Bulkhead Mount Solder Connector to suit RG214 cable



C = 4.0 mm

7932-3

N-Type Female Bulkhead Mount Crimp Connector to suit RG214 cable



A = 18.0 mm
B = 5.8 mm
C = 4.5 mm

7938

N-Type Female Crimp Connector to suit RG58 cable

Tri-Metal Plated
Low PIM



A = 19.0 mm
B = 8.0 mm
C = 4.0 mm

7939

N-Type Female Crimp Connector to suit RG213 cable



A = 15.4 mm
C = 4.0 mm

7984

N-Type Female Cap and Chain



7997

N-Type Female Flange Mount Solder Connector to suit RG58 cable



A = 8.0 mm
C = 4.0 mm

7998

N-Type Female Bulkhead Mount Crimp Connector to suit RG58 cable



A = 15.2 mm
B = 7.7 mm
C = 5.0 mm

8227

N-Type Female Crimp Connector to suit RU400 or RG8 cable

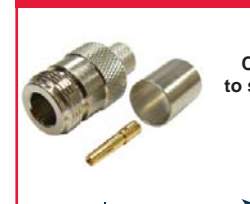

A = 14.0 mm
B = 9.0 mm
C = 5.0 mm